

PLAN

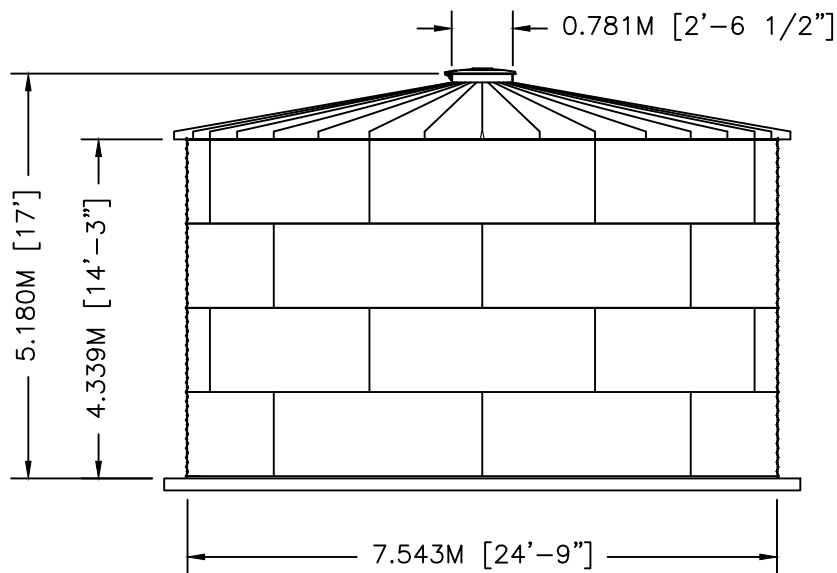

ELEVATION

STEEL CORE TANK, LLC.
WWW.STEELCORETANK.COM
 (844) 225-0881

	BY	DATE
DWN	XXX	XX/XX/XX
CKD		
ENG		

TITLE STEELCORE WATER TANK SCT-2404-LVR
 WTU08-04 30"PR 10DEG V-RIB
 NOMINAL CAPACITY - 188.434 M3 [49,779 GAL]

DWG. NO. SCT2404-LVR WTU08-04 REV. NO.

THIS DRAWINGS DEPICTED ON THIS PRINT AND INFORMATION CONTAINED HEREIN ARE PROPRIETARY TO STEEL CORE TANK, LLC. AND SHALL NOT BE USED IN WHOLE OR PART WITHOUT WRITTEN CONSENT OF STEEL CORE TANK, LLC. 2016

SIZE: A SCALE: 1/8"=1'-0" SHEET 1 OF 1