

PLAN

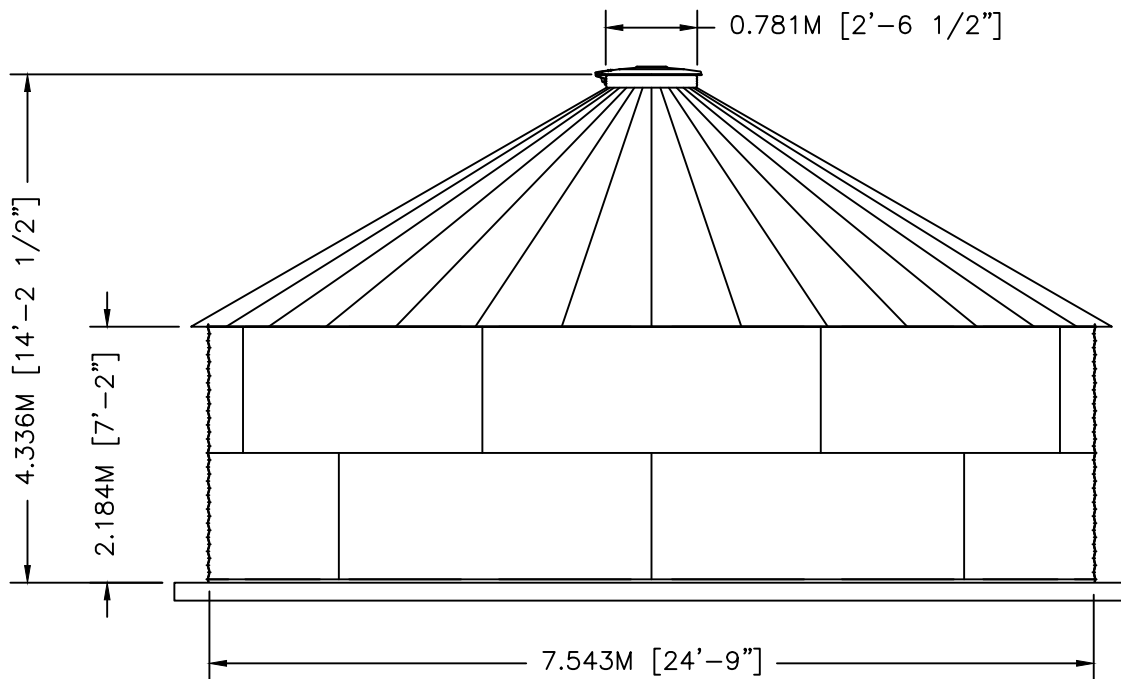

ELEVATION

STEEL CORE TANK, LLC.
WWW.STEELCORETANK.COM
 (844) 225-0881

	BY	DATE
DWN	XXX	XX/XX/XX
CKD		
ENG		

TITLE	STEELCORE WATER TANK SCT-2402-VR WTU08-02 30"PR 30DEG V-RIB NOMINAL CAPACITY - 91.948 M3 [24,290 GAL]	
DWG. NO.	SCT2402-VR WTU08-02	REV. NO.

THIS DRAWINGS DEPICTED ON THIS PRINT AND INFORMATION CONTAINED HEREIN ARE PROPRIETARY TO STEEL CORE TANK, LLC. AND SHALL NOT BE USED IN WHOLE OR PART WITHOUT WRITTEN CONSENT OF STEEL CORE TANK, LLC. 2015

SIZE:	SCALE:	SHEET	OF
A	3/16"=1'-0"	1	1